

Cut Charts and Marking Charts

WARNING



EXPLOSION HAZARD – CUTTING WITH ALUMINUM NEAR WATER

Do not cut aluminum alloys underwater or on a water table unless you can prevent the accumulation of hydrogen gas. Never cut aluminum-lithium alloys in the presence of water.

Aluminum can react with water to produce hydrogen, resulting in a potentially explosive condition that can detonate during plasma cutting operations. Refer to the *Safety and Compliance Manual (80669C)* for more information.

WARNING



EXPLOSION HAZARD – CUTTING WITH FUEL GASES

Do not use combustible fuel gases or oxidizing gases with Powermax systems. These gases can result in explosive conditions during plasma cutting operations.

WARNING



TOXIC FUMES CAN CAUSE INJURY OR DEATH

Some metals, including stainless steel, may release toxic fumes when cut. Make sure your work site has adequate ventilation to ensure that the air quality level meets all local and national standards and regulations. Refer to the *Safety and Compliance Manual (80669C)* for more information.

Using the cut charts

The cut charts in this section are intended to provide a good starting point. Adjust the variables in the cut charts as needed to achieve optimal results for your cutting equipment and environment.

Cut charts are provided for each set of mechanized cutting and marking consumables. A consumable diagram with part numbers precedes each cut chart.

Cut charts are included for:

- Cutting mild steel, stainless steel, and aluminum at 45 A with air using shielded consumables
- Cutting mild steel and stainless steel with air using FineCut consumables
- Cutting stainless steel at 45 A with F5 using shielded consumables
- Marking and dimpling at 10 – 25 A with air and argon using Marking consumables

Each cut chart may contain the following information:

- **Amperage setting** – The amperage setting at the top of the page applies to all the settings given on that page. In FineCut charts, the amperage setting for each thickness is included in the cut chart.
- **Material Thickness** – Thickness of the workpiece (metal plate being cut).
- **Torch-to-Work Distance** – For shielded consumables, the distance between the shield and the workpiece during cutting. For unshielded consumables, the distance between the nozzle and the workpiece during cutting. This is also known as cut height.
- **Initial Pierce Height** – Distance between the shield (shielded) or the nozzle (unshielded) and the workpiece when the torch is fired, prior to descending to the cut height. In marking charts, this is referred to as *Initial Marking Height*.
- **Pierce Delay Time** – Length of time the triggered torch remains stationary at the pierce height before the torch starts the cutting motion. In marking charts, this is referred to as *Delay Time*.
- **Best Quality Settings** (cut speed and voltage) – Settings that provide the starting point for finding the best cut quality (best angle, least dross, best cut-surface finish). Adjust the speed for your application and table to obtain the desired result.
- **Production Settings** (cut speed and voltage) – 70% to 80% of the maximum speed ratings. These speeds result in the greatest number of cut parts, but not necessarily the best possible cut quality.



The arc voltage increases as the consumables wear, so the voltage setting may need to be increased to maintain the correct torch-to-work distance. Some CNCs monitor the arc voltage and adjust the torch lifter automatically.

- **Kerf Width** – Width of material removed by the cutting process. The kerf widths were obtained with the “Best Quality” settings and are for reference only. Differences between installations and material composition may cause actual results to vary from those shown in the tables.
- **Width and Depth** – The marking and dimpling cut charts list the profile dimensions of the mark or dimple.

Each cut chart lists hot and cold gas flow rates.

- **Hot flow rate** – Plasma is on, the system is operating at running current, and the system is in a steady state at the default system pressure (cutflow, or automatic mode).
- **Cold flow rate** – Plasma is off and the system is in a steady state with gas flowing through the torch at the default system pressure (postflow).



Hypertherm collected the cut chart data under laboratory test conditions using new consumables.

Mild Steel – 45 A – Air – Shielded

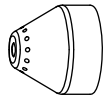

220817

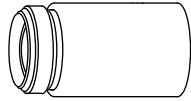

220854
(220953 for
ohmic sensing)



220941

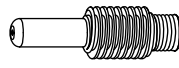

220842

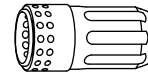

220857

Metric

Material Thickness	Torch-to-Work Distance	Initial Pierce Height		Pierce Delay Time	Best Quality Settings		Production Settings		Kerf Width
					Cut Speed	Voltage	Cut Speed	Voltage	
mm	mm	mm	%	seconds	mm/min	volts	mm/min	volts	mm
2	1.5	3.8	250	0.2	5560	128	7910	125	1.4
3					3960	128	5590	128	
4				0.4	2800	128	3960	128	1.5
6					1430	130	2110	127	
8					0.6	1020	133	1385	
10				780		136	920	134	
12				Edge Start	1	540	140	690	138
16	310	146	400		141	2.1			
20	170	152	240		147	2.3			
25	110	157	145		154	3			

English

Material Thickness	Torch-to-Work Distance	Initial Pierce Height		Pierce Delay Time	Best Quality Settings		Production Settings		Kerf Width
					Cut Speed	Voltage	Cut Speed	Voltage	
inches	inches	inches	%	seconds	in/min	volts	in/min	volts	inches
16 GA	0.06	0.15	250	0.1	249	128	320	125	0.053
14 GA					225	128	320	125	0.054
10 GA				0.4	129	128	181	128	0.057
3/16					85	129	122	127	0.059
1/4					0.6	48	130	72	127
3/8				33		136	38	133	0.069
1/2				Edge Start	1	18	141	24	139
5/8	13	146	16		141	0.082			
3/4	7	151	10		145	0.086			
7/8	6	154	7		151	0.103			
1	4	157	6	154	0.119				

Gas flow rate – slpm / scfh

151 / 320	Hot (cutflow)
184 / 390	Cold (postflow)

Stainless Steel – 45 A – Air – Shielded

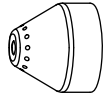

220817

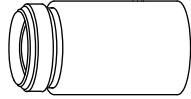

220854
(220953 for
ohmic sensing)



220941

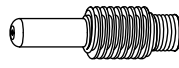

220842

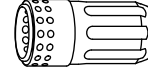

220857

Metric

Material Thickness	Torch-to-Work Distance	Initial Pierce Height		Pierce Delay Time	Best Quality Settings		Production Settings		Kerf Width
					Cut Speed	Voltage	Cut Speed	Voltage	
mm	mm	mm	%	seconds	mm/min	volts	mm/min	volts	mm
2	1.5	3.8	250	0.1	5620	126	7830	129	0.6
3				0.2	3285	129	4725	128	0.9
4				0.4	1995	130	2960	129	1.1
6				0.6	1145	131	1695	131	1.2
8				0.8	830	134	1100	134	1.4
10		0.8	605	137	870	137	1.6		
12	4.6	300	1.2	380	141	540	139	1.8	
16	Edge Start			240	145	320	142	2.4	
20	Edge Start			160	149	205	146	3.1	

English

Material Thickness	Torch-to-Work Distance	Initial Pierce Height		Pierce Delay Time	Best Quality Settings		Production Settings		Kerf Width
					Cut Speed	Voltage	Cut Speed	Voltage	
inches	inches	inches	%	seconds	in/min	volts	in/min	volts	inches
16 GA	0.06	0.15	250	0.1	237	125	320	128	0.017
14 GA				0.2	230	126	320	129	0.022
10 GA				0.4	90	130	134	128	0.041
3/16				0.5	63	131	93	130	0.044
1/4				0.6	40	131	59	131	0.047
3/8		0.8	26	137	29	136	0.061		
1/2		0.18	300	1.2	12	142	19	140	0.075
5/8		Edge Start			10	145	13	142	0.096
3/4	Edge Start			7	148	9	145	0.116	
7/8	Edge Start			5	151	6	149	0.137	

Gas flow rate – slpm / scfh

151 / 320	Hot (cutflow)
184 / 390	Cold (postflow)

Aluminum - 45 A - Air - Shielded

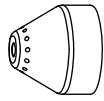

220817

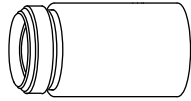

220854
(220953 for
ohmic sensing)



220941

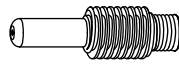

220842

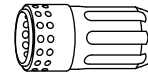

220857

Metric

Material Thickness	Torch-to-Work Distance	Initial Pierce Height		Pierce Delay Time	Best Quality Settings		Production Settings		Kerf Width	
					Cut Speed	Voltage	Cut Speed	Voltage		
mm	mm	mm	%	seconds	mm/min	volts	mm/min	volts	mm	
2	1.5	3.8	250	0.1	7890	121	9585	134	1.3	
3				0.2	4850	130	7120	129		1.5
4				0.4	3670	133	5650	129		
6				0.5	2060	139	3095	132	1.6	
8				0.6	1330	139	1830	136	1.7	
10				0.7	860	142	1015	140	1.9	
12				Edge Start			620	144	745	142
16	Edge Start			360	152	340	148	2.5		

English

Material Thickness	Torch-to-Work Distance	Initial Pierce Height		Pierce Delay Time	Best Quality Settings		Production Settings		Kerf Width		
					Cut Speed	Voltage	Cut Speed	Voltage			
inches	inches	inches	%	seconds	in/min	volts	in/min	volts	inches		
1/10	0.06	0.15	250	0.2	240	126	320	131	0.056		
1/8				0.4	170	131	263	128	0.060		
3/16				0.4	120	134	184	130	0.061		
1/4				0.5	70	137	104	132	0.063		
3/8				0.7	36	141	42	139	0.073		
1/2				Edge Start			21	145	26	143	0.082
5/8				Edge Start			15	152	14	148	0.100
3/4	Edge Start			8	158	9	153	0.117			

Gas flow rate - slpm / scfh

151 / 320	Hot (cutflow)
184 / 390	Cold (postflow)

Mild Steel – FineCut – Air – Shielded and Unshielded

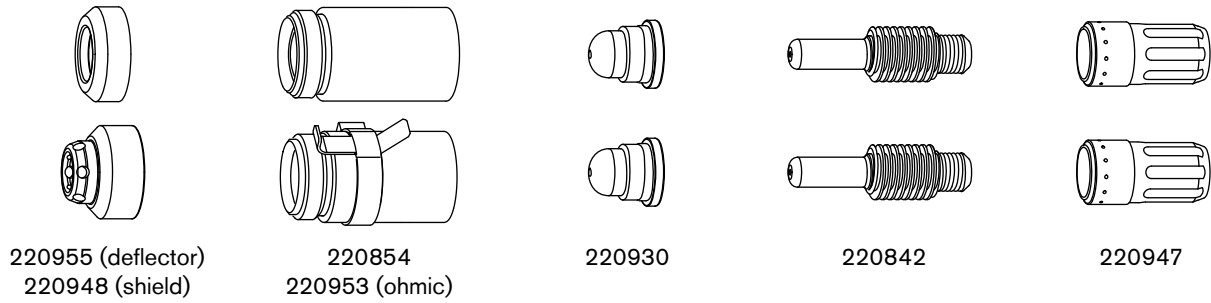

Metric

Material Thickness	Current	Torch-to-Work Distance	Initial Pierce Height		Pierce Delay Time	Recommended		Kerf Width			
			mm	%		Cut Speed	Voltage				
mm	A	mm	mm	%	seconds	mm/min	volts	mm			
0.5	40	1.5	3.8	250	0.0	8250	78	0.7			
0.6						8250	78				
0.8						8250	78				
1	45				0.1	0.2	0.4	8250	78	0.6	
1.5								6400	78	0.7	
2								0.5	4800	78	1.2
3									2500	78	
4									1900	78	

English

Material Thickness	Current	Torch-to-Work Distance	Initial Pierce Height		Pierce Delay Time	Best Quality Settings		Kerf Width			
			inches	%		Cut Speed	Voltage				
inches	A	inches	inches	%	seconds	in/min	volts	inches			
26 GA	40	0.06	0.15	250	0.0	325	78	0.025			
24 GA						325	78	0.029			
22 GA						325	78	0.024			
20 GA	45				0.1	0.2	0.4	325	78	0.020	
18 GA								325	78	0.043	
16 GA								0.5	250	78	0.046
14 GA									200	78	0.049
12 GA									120	78	0.052
10 GA	95	78	0.051								

Gas flow rate – slpm / scfh

155 / 330	Hot (cutflow)
215 / 460	Cold (postflow)

Stainless Steel – FineCut – Air – Shielded and Unshielded

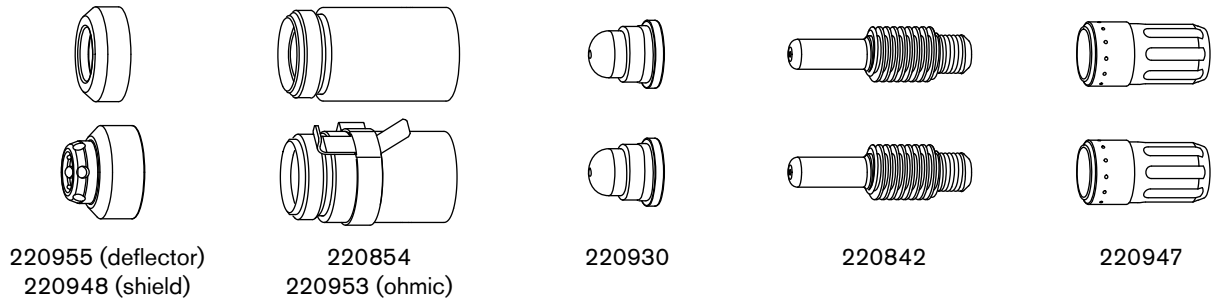

Metric

Material Thickness	Current	Torch-to-Work Distance	Initial Pierce Height		Pierce Delay Time	Recommended		Kerf Width			
			mm	%		Cut Speed	Voltage				
mm	A	mm	mm	%	seconds	mm/min	volts	mm			
0.5	40	0.5	2.0	400	0.0	8250	68	0.6			
0.6						8250	68				
0.8						8250	68	0.5			
1	45				0.2	8250	68		0.6		
1.5					0.4	6150	70				
2	45				0.5	2.0	400	0.5	4800	71	1.0
3									2550	80	
4									1050	84	1.5

English

Material Thickness	Current	Torch-to-Work Distance	Initial Pierce Height		Pierce Delay Time	Best Quality Settings		Kerf Width			
			inches	%		Cut Speed	Voltage				
inches	A	inches	inches	%	seconds	in/min	volts	inches			
26 GA	40	0.02	0.08	400	0.0	325	68	0.024			
24 GA						325	68	0.021			
22 GA						325	68	0.018			
20 GA	45				0.02	0.08	400	0.1	325	68	0.017
18 GA									325	68	0.036
16 GA	45							0.02	0.08	400	0.2
14 GA					200	70	0.040				
12 GA					0.5	120	80				0.049
10 GA		0.6	75	80	0.055						

Gas flow rate – slpm / scfh

155 / 330	Hot (cutflow)
215 / 460	Cold (postflow)

Mild Steel – FineCut Low Speed – Air – Shielded and Unshielded

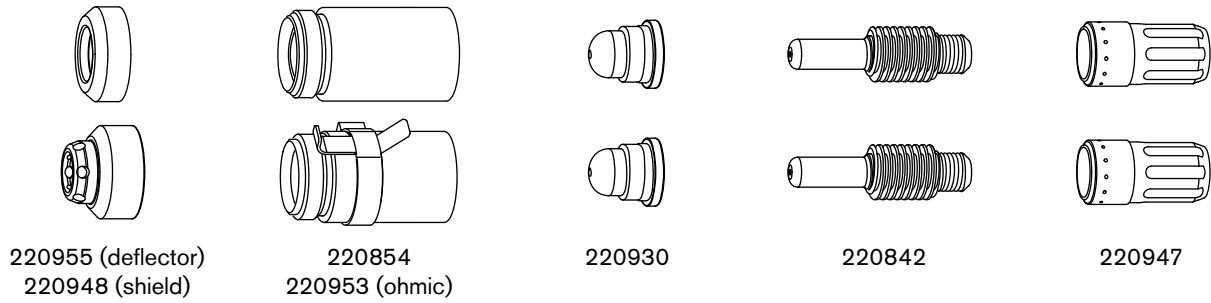

Metric

Material Thickness	Current	Torch-to-Work Distance	Initial Pierce Height		Pierce Delay Time	Recommended		Kerf Width
			mm	%		Cut Speed	Voltage	
mm	A	mm	mm	%	seconds	mm/min	volts	mm
0.5	30	1.5	3.8	250	0.0	3800	69	0.6
0.6						3800	68	
0.8						3800	70	
1*	40				0.1	3800	72	0.8
1.5*						3800	75	
2	45				0.4	3700	76	0.7
3						0.5	2750	78
4					0.6	1900	78	1.5

English

Material Thickness	Current	Torch-to-Work Distance	Initial Pierce Height		Pierce Delay Time	Best Quality Settings		Kerf Width
			inches	%		Cut Speed	Voltage	
inches	A	inches	inches	%	seconds	in/min	volts	inches
26 GA	30	0.06	0.15	250	0.0	150	70	0.026
24 GA						150	68	0.024
22 GA					0.1	150	70	0.025
20 GA	150					71		
18 GA	40				0.2	150	73	0.031
16 GA*						0.4	150	75
14 GA*	150				76		0.027	
12 GA	45				0.5	120	78	0.052
10 GA		95	78	0.051				

Gas flow rate – slpm / scfh

155 / 330	Hot (cutflow)
215 / 460	Cold (postflow)

* Not a dress-free cut.

Stainless Steel – FineCut Low Speed – Air – Shielded and Unshielded

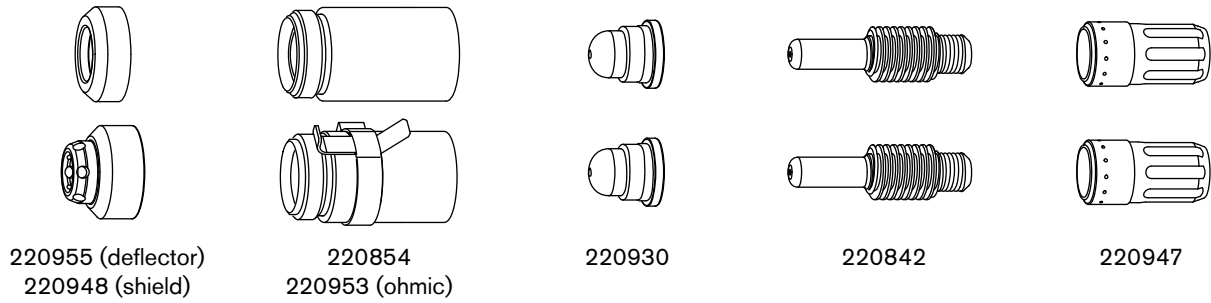

Metric

Material Thickness	Current	Torch-to-Work Distance	Initial Pierce Height		Pierce Delay Time	Recommended		Kerf Width							
			mm	%		Cut Speed	Voltage								
mm	A	mm	mm	%	seconds	mm/min	volts	mm							
0.5	30	0.5	2.0	400	0.0	3800	69	0.7							
0.6						3800	69								
0.8						3800	69								
1	40				0.5	2.0	400	0.2	3800	69	0.6				
1.5									2900	69	0.5				
2								45	0.5	2.0	400	0.4	2750	69	1.3
3													2550	80	1.4
4	1050				80	1.5									

English

Material Thickness	Current	Torch-to-Work Distance	Initial Pierce Height		Pierce Delay Time	Best Quality Settings		Kerf Width							
			inches	%		Cut Speed	Voltage								
inches	A	inches	inches	%	seconds	in/min	volts	inches							
26 GA	30	0.02	0.08	400	0.0	150	69	0.028							
24 GA						150	69								
22 GA						150	69								
20 GA	40				0.02	0.08	400	0.1	150	69	0.023				
18 GA									145	69					
16 GA								45	0.02	0.08	400	0.4	115	69	0.022
14 GA													110	69	0.021
12 GA	45				0.02	0.08	400	0.5	120	80	0.049				
10 GA		75	80	0.055											

Gas flow rate – slpm / scfh

155 / 330	Hot (cutflow)
215 / 460	Cold (postflow)

Stainless Steel – 45 A – F5 – Shielded

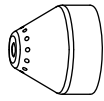

220817

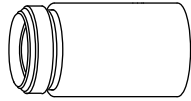

220854
(220953 for
ohmic sensing)



220941

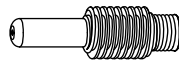

220842

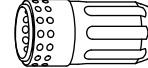

220857

Metric

Material Thickness	Torch-to-Work Distance	Initial Pierce Height		Pierce Delay Time	Best Quality Settings		Production Settings		Kerf Width
					Cut Speed	Voltage	Cut Speed	Voltage	
mm	mm	mm	%	seconds	mm/min	volts	mm/min	volts	mm
8	1.5	3.8	250	0.8	630	150	860	144	2.1
10					435	153	525	147	2.3
12		Edge Start			340	156	440	150	2.5

English

Material Thickness	Torch-to-Work Distance	Initial Pierce Height		Pierce Delay Time	Best Quality Settings		Production Settings		Kerf Width
					Cut Speed	Voltage	Cut Speed	Voltage	
inches	inches	inches	%	seconds	in/min	volts	in/min	volts	inches
1/4	0.06	0.15	250	0.6	32	147	47	141	0.075
3/8				0.8	18	152	22	146	0.088
1/2		Edge Start		12	157	16	151	0.101	

Gas flow rate – slpm / scfh

149 / 315	Hot (cutflow)
184 / 390	Cold (postflow)



F5 is not recommended for thicknesses less than 7 mm or 1/4 inch or for use with FineCut consumables.

Marking and Dimpling – Air – Shielded

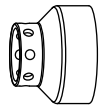

420542

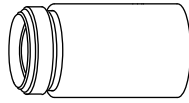

220854
(220953 for
ohmic sensing)



420415

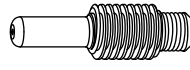

220842

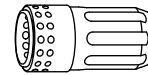

220857

Mild steel

Current A	Torch-to-Work Distance		Initial Marking Height		Delay Time seconds	Marking Speed		Arc Voltage volts	Width		Depth	
	mm	in	mm	in		mm/min	in/min		mm	in	mm	in
Light marking												
10	6.4	0.25	6.4	0.25	0	2540	100	134	2.79	0.11	<0.02	<0.001
Heavy marking												
10	4.6	0.18	4.6	0.18	0	2540	100	111	2.79	0.11	0.09	0.0035
Dimpling												
10	6.4	0.25	—	—	0.05	—	—	—	1.98	0.078	0.25	0.01

Stainless steel

Current A	Torch-to-Work Distance		Initial Marking Height		Delay Time seconds	Marking Speed		Arc Voltage volts	Width		Depth	
	mm	in	mm	in		mm/min	in/min		mm	in	mm	in
Light marking												
10	5.1	0.2	5.1	0.2	0	5080	200	123	2.03	0.08	<0.02	<0.001
Heavy marking												
10	6.4	0.25	6.4	0.25	0	3175	125	133	2.54	0.1	0.08	0.003
Dimpling												
10	6.4	0.25	—	—	0.05	—	—	—	2.03	0.08	0.23	0.009

Aluminum

Current A	Torch-to-Work Distance		Initial Marking Height		Delay Time seconds	Marking Speed		Arc Voltage volts	Width		Depth	
	mm	in	mm	in		mm/min	in/min		mm	in	mm	in
Marking												
11	2.5	0.1	5.1	0.2	0	5080	200	98	0.89	0.035	<0.02	<0.001
Dimpling												
10	3.2	0.125	—	—	0.15	—	—	—	0.89	0.035	0.09	0.0035

Gas flow rate – slpm / scfh

136 / 290	Hot (cutflow)
141 / 300	Cold (postflow)

Marking and Dimpling – Argon – Shielded

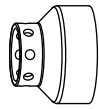

420542

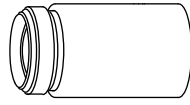
220854
(220953 for
ohmic sensing)

420415

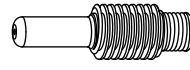

220842

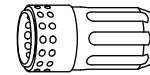

220857

Mild steel

Current A	Torch-to-Work Distance		Initial Marking Height		Delay Time seconds	Marking Speed		Arc Voltage volts	Width		Depth	
	mm	in	mm	in		mm/min	in/min		mm	in	mm	in
Light marking												
10	2.0	0.08	2.0	0.08	0	3175	125	44	1.22	0.048	<0.02	<0.001
Heavy marking												
15	1.5	0.06	1.5	0.06	0	3175	125	42	1.22	0.048	<0.02	<0.001
Dimpling												
20	3.2	0.125	—	—	0.25	—	—	—	0.99	0.039	<0.02	<0.001

Stainless steel

Current A	Torch-to-Work Distance		Initial Marking Height		Delay Time seconds	Marking Speed		Arc Voltage volts	Width		Depth	
	mm	in	mm	in		mm/min	in/min		mm	in	mm	in
Light marking												
12	2.5	0.1	2.5	0.1	0	3175	125	46	1.40	0.055	<0.02	<0.001
Heavy marking												
15	2.5	0.1	2.5	0.1	0	2540	100	46	2.16	0.085	0.02	0.001
Dimpling												
10	3.2	0.125	—	—	0.25	—	—	—	0.94	0.037	0.18	0.007

Aluminum

Current A	Torch-to-Work Distance		Initial Marking Height		Delay Time seconds	Marking Speed		Arc Voltage volts	Width		Depth	
	mm	in	mm	in		mm/min	in/min		mm	in	mm	in
Marking												
16	0.5	0.02	0.5	0.02	0	4445	175	42	0.63	0.025	<0.02	<0.001
Dimpling												
20	0.5	0.02	—	—	0.4	—	—	—	0.66	0.026	0.04	0.0015

Gas flow rate – slpm / scfh

120 / 255	Hot (cutflow)
122 / 260	Cold (postflow)